

AiM Infotech

Car bike PT100
M5/M10 threads
for oil/water measurement
thermo resistor

Release 1.06





1

Introduction

AiM car bike devices can measure and sample water and oil temperature using a sensor (thermo-resistor) placed in the cooling system or in the oil cup.

Sensor part numbers are:

- | | | |
|-------------------------|-------------|---------------------------|
| • PT100 thermo resistor | M10 thread: | X05TRM10A4512BPRS; |
| • PT100 thermo resistor | M5 thread: | X025TRM05A4514BPR. |

To install the thermo resistors optional **inline water/oil fittings** are needed; their part numbers are:

- | | |
|--|------------------|
| • inline water/oil fitting for PT 100 thermo resistor PT100 M10 thread | LAA54120R |
| • inline water/oil fitting for PT 100 thermo resistor PT100 M5 thread | LAA541100 |

Please note: car bike sensors are not compatible with kart systems so refer to the above indicated part numbers only.

2 Installation and connection

The thermo resistor is to be placed in the coil system/oil cup.

We recommend to install the sensors far from heat sources or electromagnetic interference (like RPM cable or lap receivers).

Images below show the inline water/oil fitting on the left and the sensors installed on the right: M10 thread top and M5 thread bottom.

To install the thermo resistor in the coil system:

- cut the water pipe
- connect the inline water fitting to the pipe fixing two metal wraps in the points highlighted in the drawings below
- screw the thermo resistor in the threaded hole shown on the right.

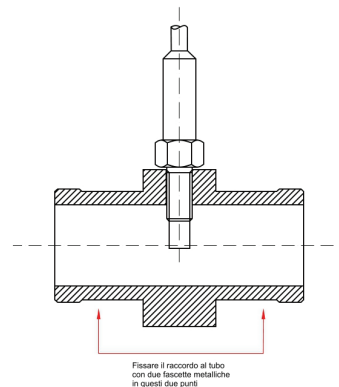
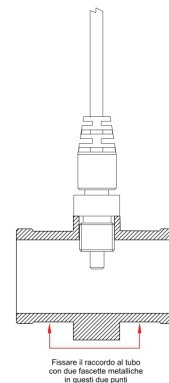

3

Dimensions, pinout and technical characteristics

The images below shows the measures of the sensors on the left and the measures of the oil/water filling on the right in millimetres [inches]: PT100 thermo-resistor M10 thread on top and PT100 thermo resistor M5 thread on bottom.

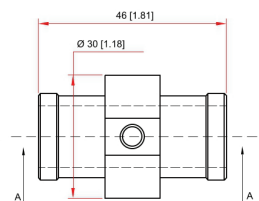
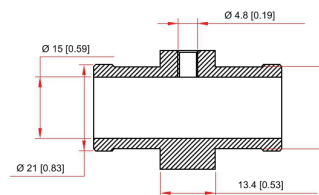
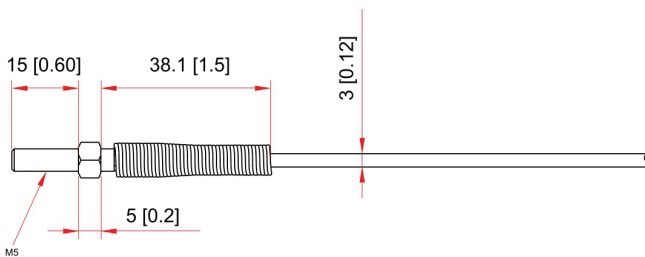
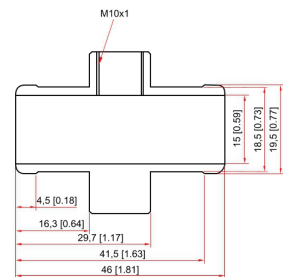
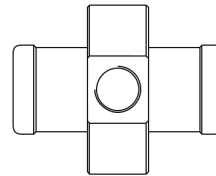
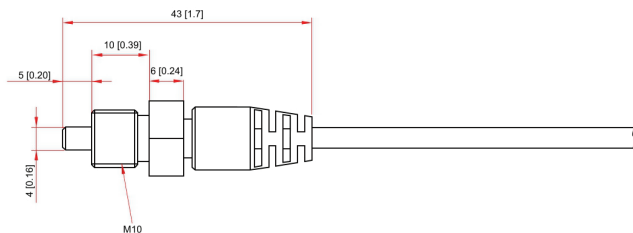

Both thermo resistors end with a **4 pins Binder 719 male connector that features a 2kΩ 1% resistor between pins 1 and 4**. Here below the connector view – sensor side on the left and device side on the right – are shown; while in the following table is connector pinout.

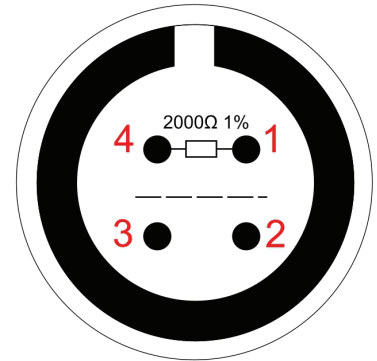
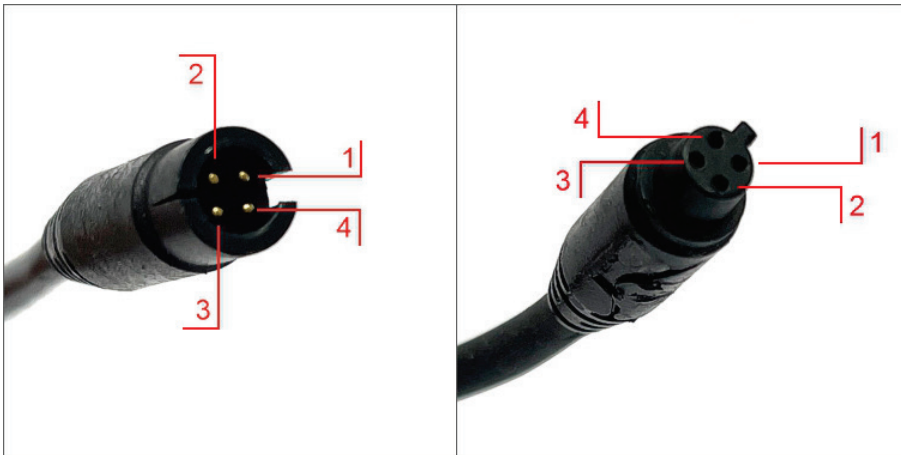

Pin	Function
1	Analog signal
2	GND
3	Not connected
4	+Vreference

The sensor technical characteristics are:

Electrical Characteristic	Valuee
Temperature working range	0/150°C
Cable length	250 mm

4

Extension cables

The sensors are sold with a 25 cm cable; standard lengths extension cables are available as optional. Extension cables part numbers change according to their length and to the device the sensor is to be connected to.

Mandatory extension cable for connection with:

- EVO4
- EVO4S
- Channel Expansion

V02PCB05BTXG – cable length: 500mm

V02PCB10BTXG – cable length: 1000mm

V02PCB15BTXG – cable length: 1500mm

V02PCB20BTXG – cable length: 2000mm

V02PCB25BTXG – cable length: 2500mm

V02PCB30BTXG – cable length: 3000mm

V02PCB35BTXG – cable length: 3500 mm

V02PCB40BTXG – cable length: 4000 mm



Mandatory extension cable for connection with:

- MXG1.2/MXP/MXS1.2
- MXG/MXL2/MXS
- MXG 1.2 Strada/MXP Strada/MXS 1.2 Strada
- MXm
- EVO5
- MXL Strada/Pista/Pro05

V02PCB05B – cable length: 500mm

V02PCB10B – cable length: 1000mm

V02PCB15B – cable length: 1500mm

V02PCB20B – cable length: 2000mm

V02PCB25B – cable length: 2500mm

V02PCB30B – cable length: 3000mm

V02PCB35B – cable length: 3500 mm

V02PCB40B – cable length: 4000 mm

